

- DE Gebrauchsanleitung
- FR Mode d'emploi
- NL Gebruikershandleiding
- GB User guide
- ES Guía del usuario
- IT Manuale di istruzioni
- SE Bruksanvisning
- CZ Uživatelská příručka
- DK Brugervejledning
- FI Käyttöohjeet
- GR Οδηγός χρήστη
- NO Brukerveiledning
- PL Instrukcja obsługi

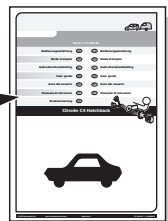

Partnr.: RN-069-DL

Gebrauchsanleitung (DE)	Uživatelská příručka (CZ)
Mode d'emploi (FR)	Brugervejledning (DK)
Gebruikershandleiding (NL)	Käyttöohjeet (FI)
User guide (GB)	Οδηγός χρήστη (GR)
Guía del usuario (ES)	Brukerveiledning (NO)
Manuale di istruzioni (IT)	Instrukcja obsługi (PL)
Bruksanvisning (SE)	

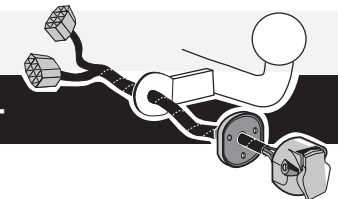

### Renault Megane Hatchback 2006-

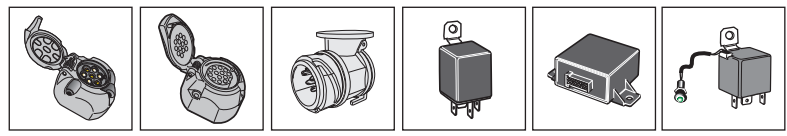
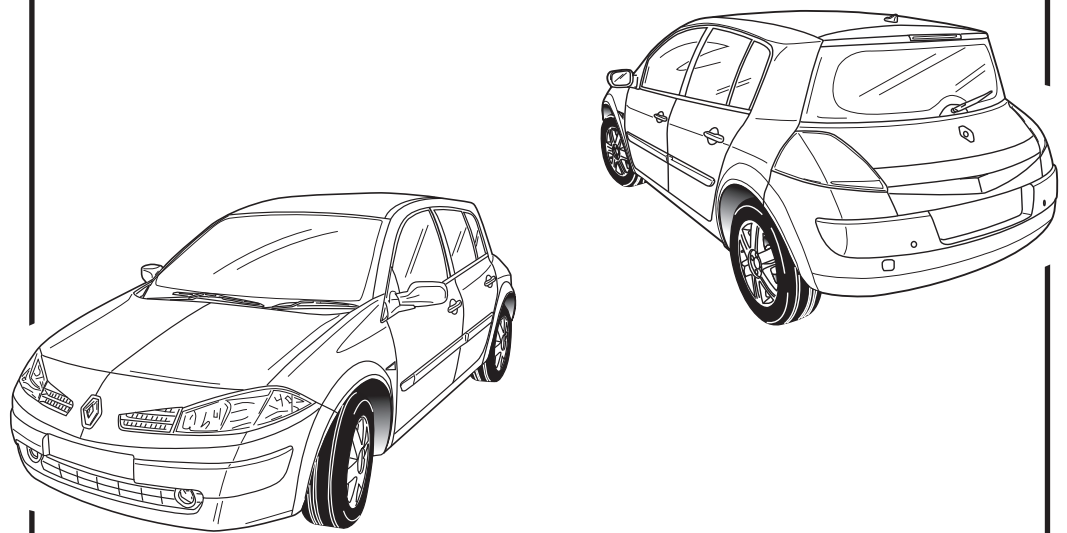

### SPARE PARTS

[www.ecs-electronics.com](http://www.ecs-electronics.com)

(DE) Anschluss Steckdose  
 (FR) Connection de la prise  
 (NL) Contactdoos aansluiting  
 (GB) Socket connection

(ES) Conexión de la caja de enchufe  
 (IT) Allaccio zoccolo  
 (SE) Anslutning kontaktdosa

(CZ) Objímkový konektor  
 (DK) Stikdåse forbindelse  
 (FI) Pistorasia liittämä

(GR) Υποδοχή σύνδεσης  
 (NO) Tilkobling koblingsboks  
 (PL) Połączenie przez gniazdo

DIV/ISO 11446	1/L	2	2a	1-8	4/R	5/58-R	6/54	7/58-L	8	9	10	11	12	13	9
Pmax	21W	2x21W	2x21W	3/31	21W	52W	3x21W	52W	2x21W	180W/15Amp	180W/15Amp	180W/15Amp	180W/15Amp	180W/15Amp	180W/15Amp
(DE)	Gelb	Blau	Grau	Weiß	Grün	Braun	Rot (1,00mm <sup>2</sup> )	Schwarz	Schwarz/ Rot	Braun/ Weiß	Rot (2,50mm <sup>2</sup> )	Weiß	Rot/ Blau	Weiß	Rot/ Blau
(FR)	Jaune	Bleu	Gris	Blanc	Vert	Marron	Rouge (1,00mm <sup>2</sup> )	Noir	Noir/ Rouge	Marron/ Blanc	Rouge (2,50mm <sup>2</sup> )	Blanc	Rouge/ Bleu	Blanc	Rouge/ Bleu
(NL)	Geel	Blauw	Grijs	Wit	Groen	Bruin	Rood (1,00mm <sup>2</sup> )	Zwart	Zwart/ Rood	Bruin/ Wit	Rood (2,50mm <sup>2</sup> )	Wit	Rood/ Blauw	Wit	Rood/ Blauw
(GB)	Yellow	Blue	Grey	White	Green	Brown	Red (1,00mm <sup>2</sup> )	Black	Black/ Red	Brown/ White	Red (2,50mm <sup>2</sup> )	White	Red/ Blue	White	Red/ Blue
(ES)	Amarillo	Azul	Gris	Blanco	Verde	Marrón	Rojo (1,00mm <sup>2</sup> )	Negro	Negro/ Rojo	Marrón/ Blanco	Rojo (2,50mm <sup>2</sup> )	Blanco	Rojo/ Azul	Blanco	Rojo/ Azul
(IT)	Giallo	Blu	Grigio	Bianco	Verde	Marrone	Rosso (1,00mm <sup>2</sup> )	Nero	Nero/ Rosso	Marrone/ Bianco	Rosso (2,50mm <sup>2</sup> )	Bianco	Rosso/ Blu	Bianco	Rosso/ Blu
(SE)	Gul	Blå	Grå	Vit	Grön	Brun	Röd (1,00mm <sup>2</sup> )	Svart	Svart/ Röd	Brun/ Vit	Röd (2,50mm <sup>2</sup> )	Vit	Röd/ Blå	Vit	Röd/ Blå
(CZ)	Žlutá	Modrá	Šedá	Bílá	Zelená	Hnědá	Červená (1,00mm <sup>2</sup> )	Černá	Černo/ Červená	Hnědo/ Bílá	Červená (2,50mm <sup>2</sup> )	Bílá	Červená/ Modrá	Bílá	Červená/ Modrá
(DK)	Gul	Blå	Grå	Hvid	Grøn	Brun	Rød (1,00mm <sup>2</sup> )	Sort	Sort/ Rød	Brun/ Hvid	Rød (2,50mm <sup>2</sup> )	Hvid	Rød/ Blå	Hvid	Rød/ Blå
(FI)	Keltainen	Sininen	Harmaa	Valkoinen	Vihreä	Ruskea	Punainen (1,00mm <sup>2</sup> )	Musta	Musta/ Punainen	Ruskea/ Valkoinen	Punainen (2,50mm <sup>2</sup> )	Valkoinen	Punainen/ Sininen	Valkoinen	Punainen/ Sininen
(GR)	Κίτρινο	Μπλε	Γκρι	Λευκό	Πράσινο	Καφέ	Κόκκινο (1,00mm <sup>2</sup> )	Μαύο	Μαύο/ Κόκκινο	Καφέ/ Λευκό	Κόκκινο (2,50mm <sup>2</sup> )	Λευκό	Κόκκινο/ Μπλε	Λευκό	Κόκκινο/ Μπλε
(NO)	Gul	Blå	Grå	Hvit	Grønn	Brun	Rød (1,00mm <sup>2</sup> )	Svart	Svart/ Rød	Brun/ Hvit	Rød (2,50mm <sup>2</sup> )	Hvit	Rød/ Blå	Hvit	Rød/ Blå
(PL)	Żółty	Niebieski	Szary	Biały	Zielony	Brązowy	Czerwonony (1,00mm <sup>2</sup> )	Czarny	Czarny/ Czerwonony	Brązowy/ Biały	Czerwonony (2,50mm <sup>2</sup> )	Biały	Czerwonony/ Niebieski	Biały	Czerwonony/ Niebieski

(DE) Sicherungen austauschen  
 (FR) Remplacer les fusibles  
 (NL) Zekeringen vervangen  
 (GB) Changing the fuse

(ES) Cambio de fusible  
 (IT) Sostituire i fusibili  
 (SE) Byte av säkringar

(CZ) Výměna pojistky  
 (DK) Udskiftning af sikringer  
 (FI) Vaihtoa varokkeet

(GR) Αλλαγή ασφάλειας  
 (NO) Skifte sikringene  
 (PL) Wymienić bezpieczniki

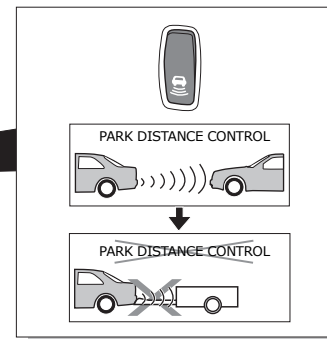
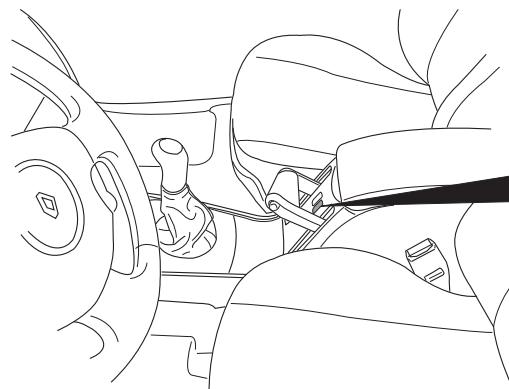
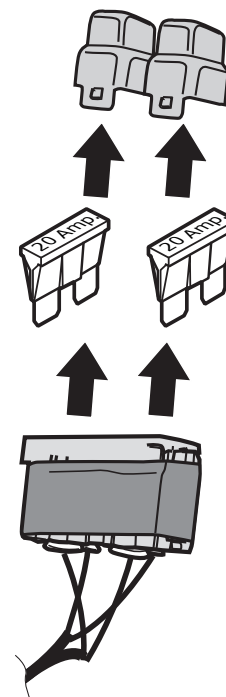
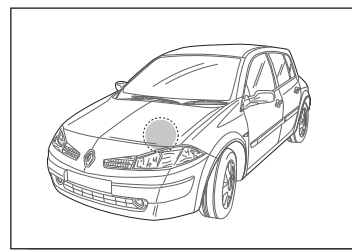

INFO : Storage

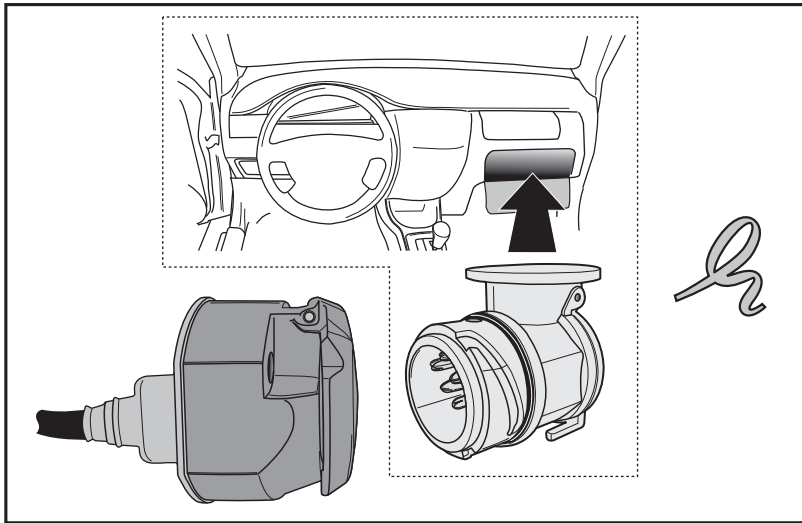
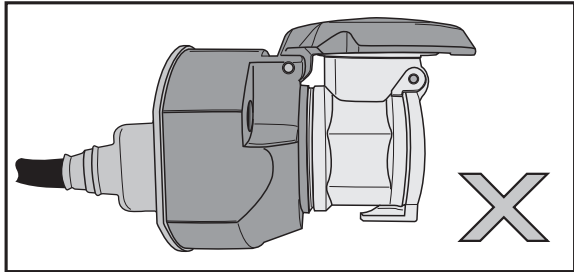
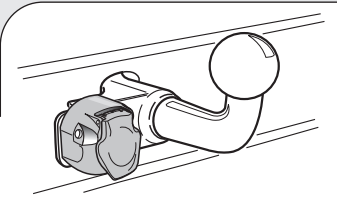
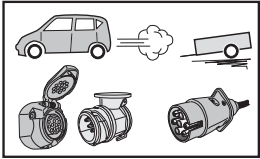

INFO

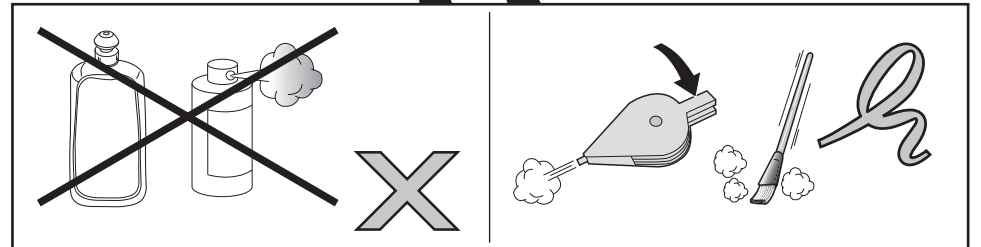
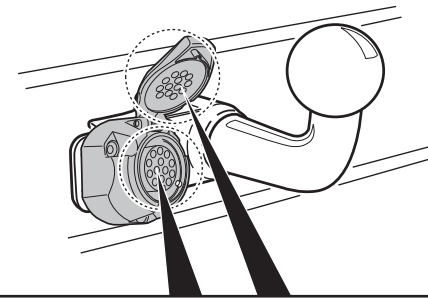
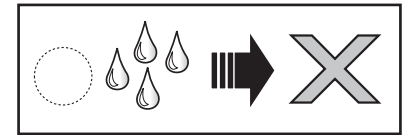
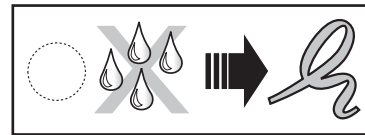
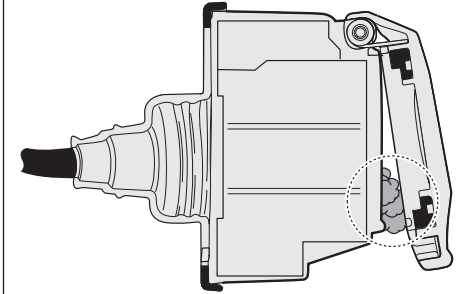
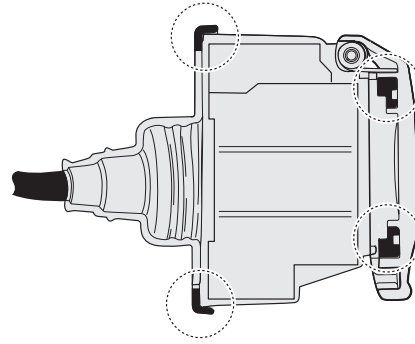
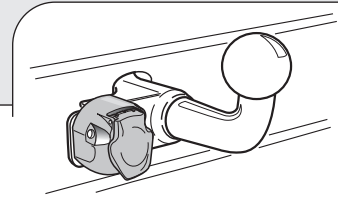
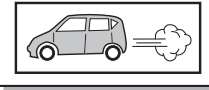

INFO : Ring.

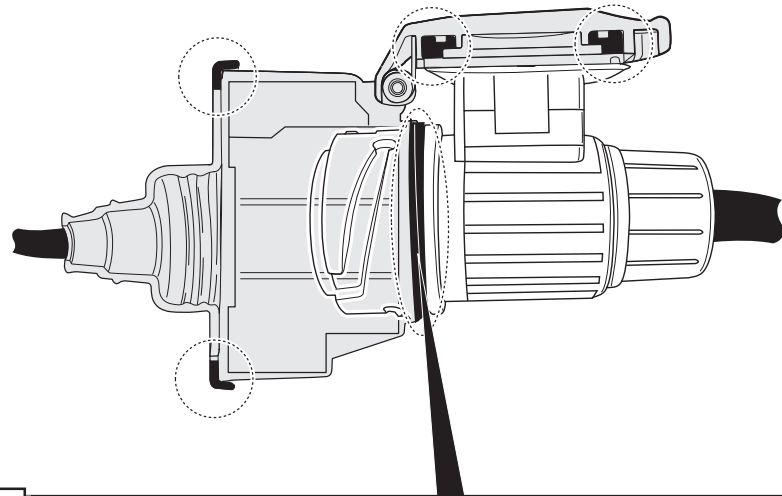
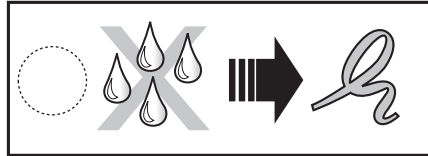
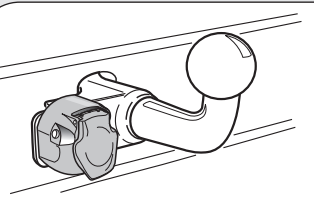
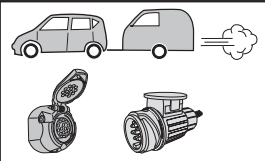

INFO

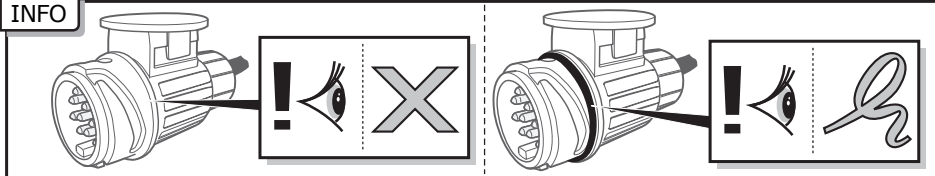

INFO : Adapt.

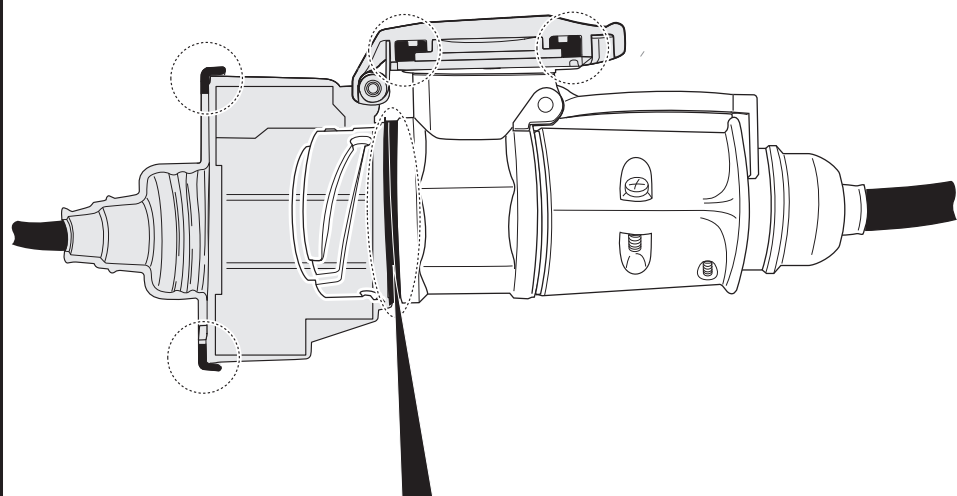
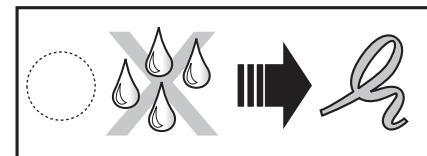
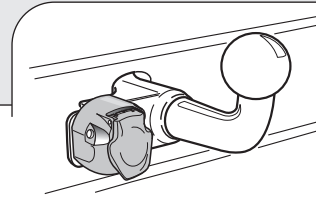
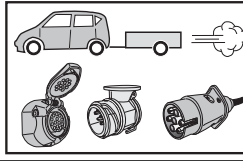

INFO

